

# Coping Unit (Holes drilled on site by other,s)

## 3 Type Standard

- F.T.C = Flat top Coping
- O.W.C = Once weathered Coping
- T.W.C = Twice weathered Coping

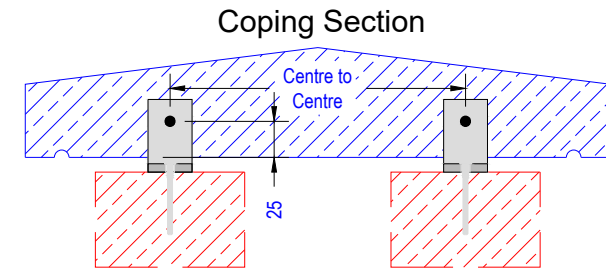
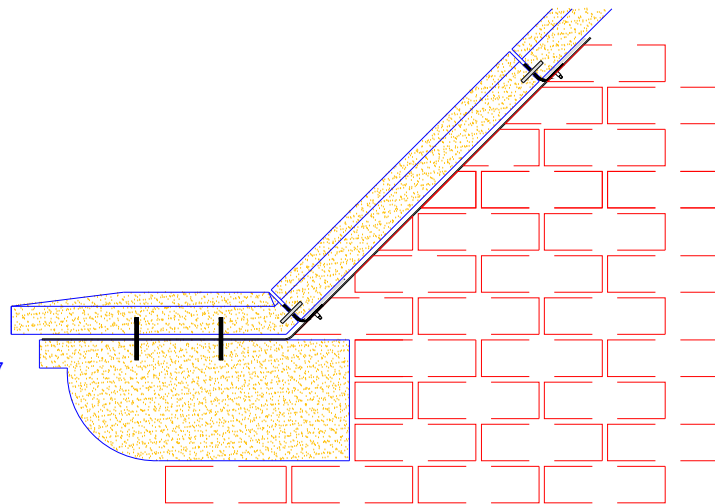
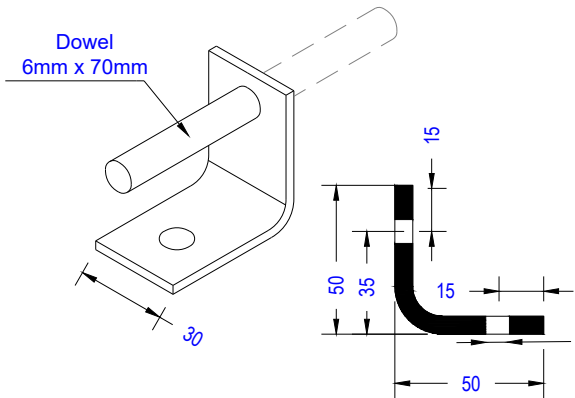
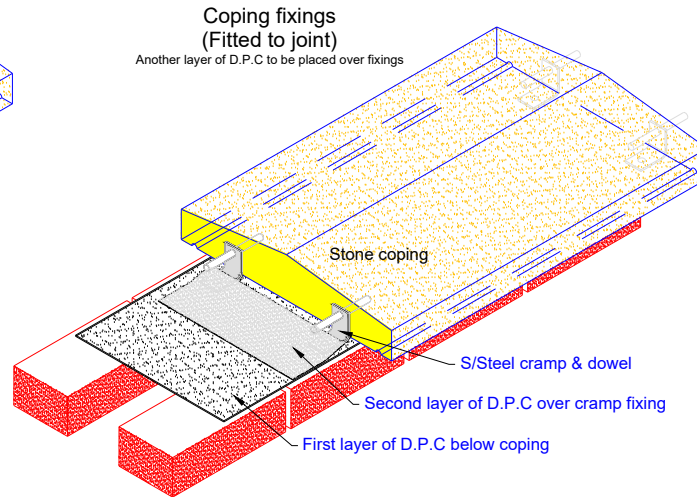
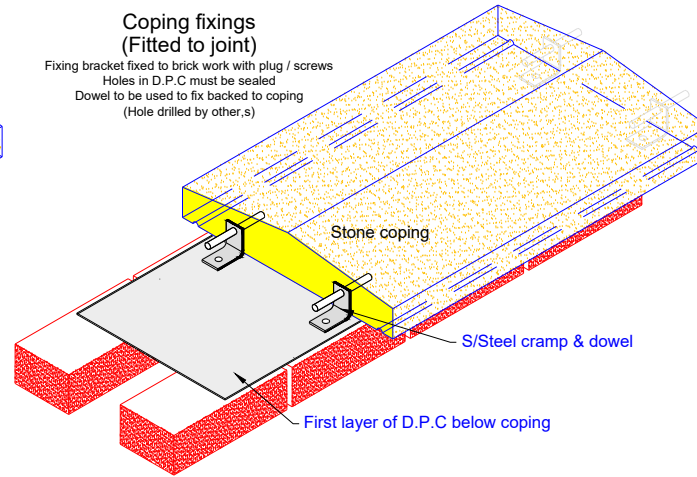
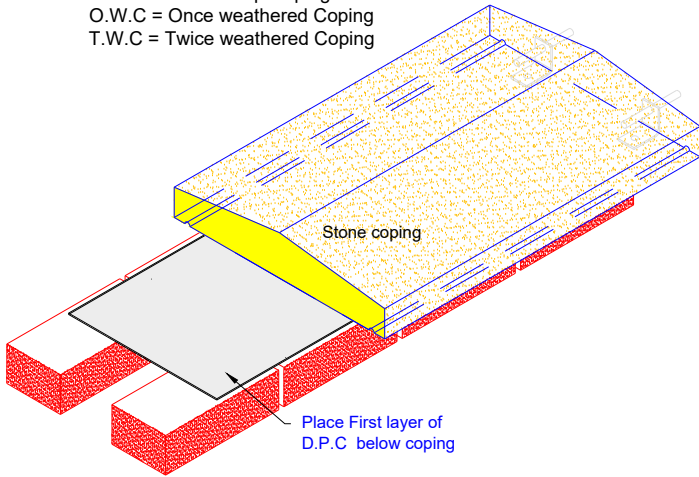

3mm Stainless steel cramp fixing

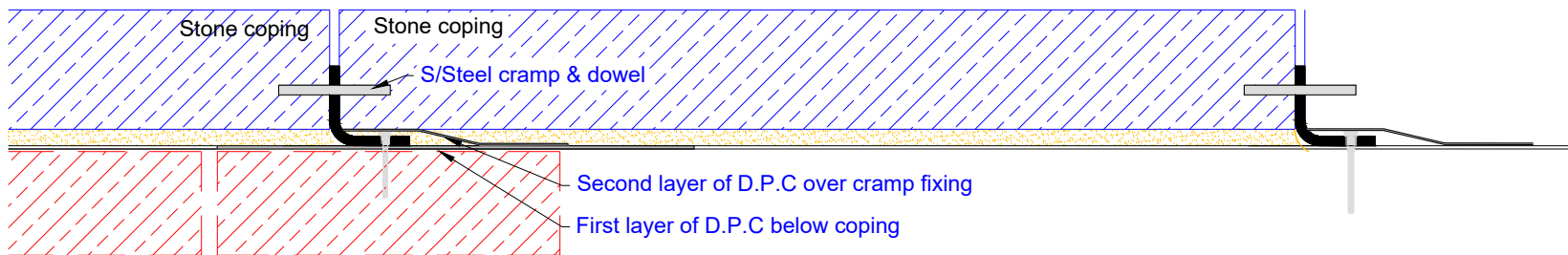

# Installation advice Raking Coping & Water Table Fixing Details

**ILAM STONE**  
Architectural Cast Stone Masonry

Lydford Road  
Meadow Lane  
Industrial Estate  
Alfreton  
Derbyshire- DE55 7RQ

Tel: 01773 520088 www.ilamstone.co.uk