

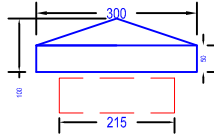

**ILAM Stone Ltd**  
 Lydford Road  
 Meadow Lane  
 Industrial Estate  
 Alfreton  
 Derbyshire DE55 7RQ  
 Phone: 01773 520088 (general)  
 Phone 01773 520142 (sales & estimating)  
 Fax 01773 520077

# Weathered Capping



Capping P1 = 300 x 300 x 100

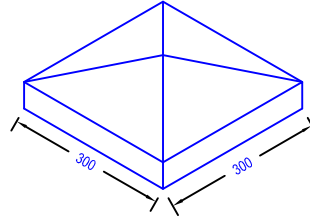

Capping P1 300 x 300 x 100

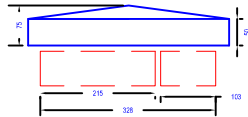

Capping P2 = 375 x 375 x 75

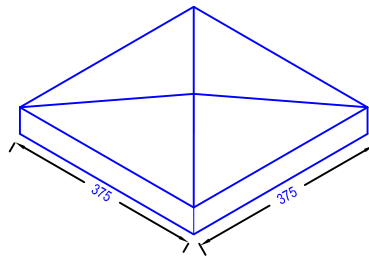

Capping P2 375 x 375 x 75

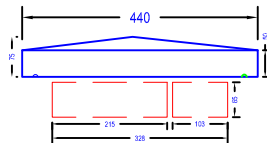

Capping PC1 = 440 x 440 x 75

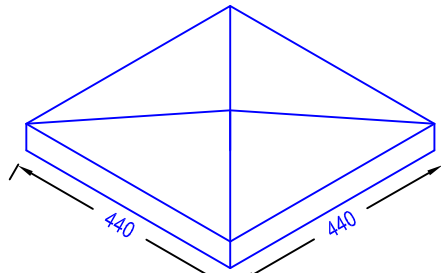

Capping PC1 440 x 440 x 75

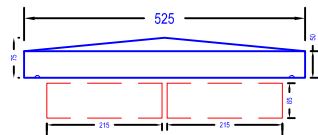

Capping PC2 = 525 x 525 x 75

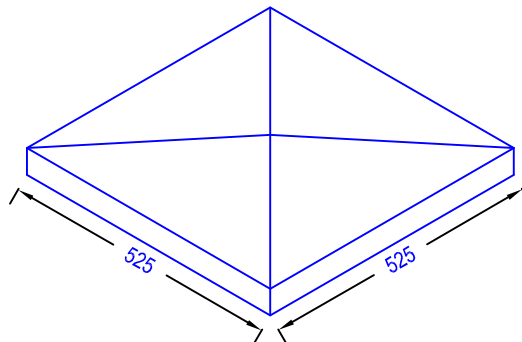

Capping PC2 525 x 525 x 75

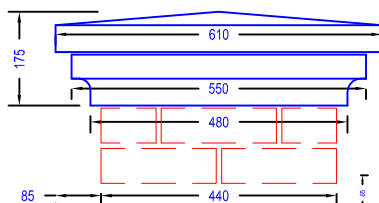

Capping PC3 610 x 610 x 75  
with MB3 = 550 x 550 x 75

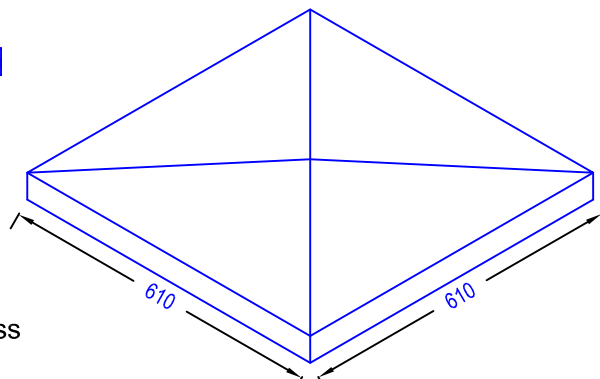

Capping PC3 610 x 610 x 75

Note :- Sphere base has a recess to take sphere

\* Other designs can be made to suit customers requirements

**ILAM**



**stone**

ILAM Stone Ltd  
Lydford Road  
Meadow Lane  
Industrial Estate  
Alfreton  
Derbyshire DE55 7RQ  
Phone: 01773 520088 (general)  
Phone 01773 520142 (sales & estimating)  
Fax 01773 520077

# Spheres & Finial Bases

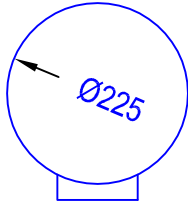

S1/225

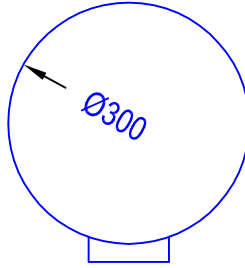

S2/300

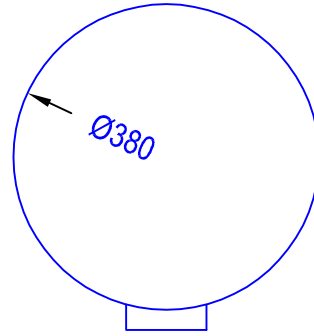

S3/380

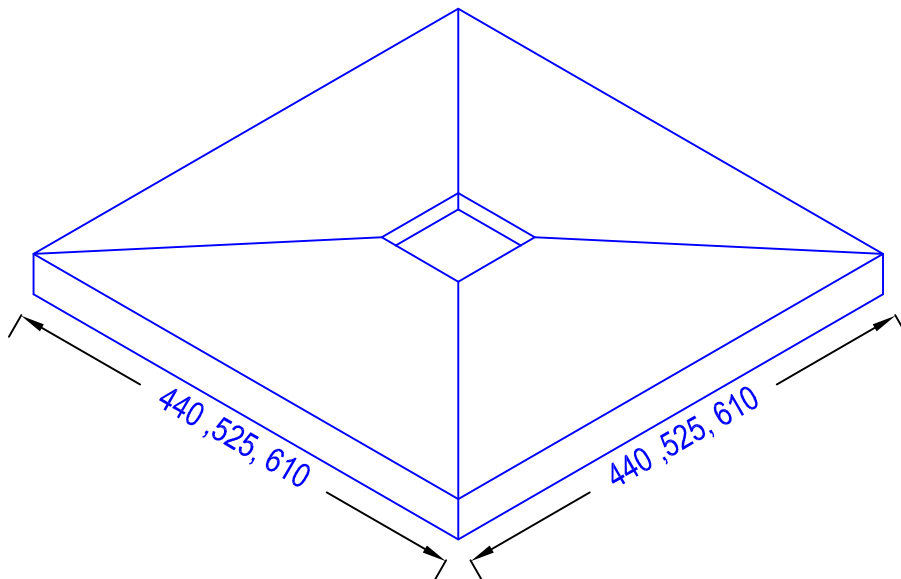

Sphere Base SB1= 440, SB2 = 525. SB3= 610,

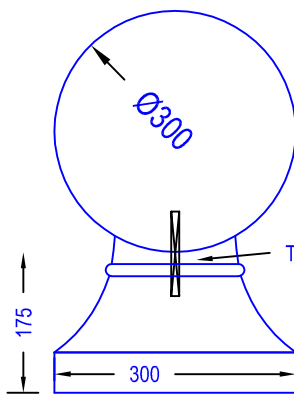

Finial Base  
SF2/300

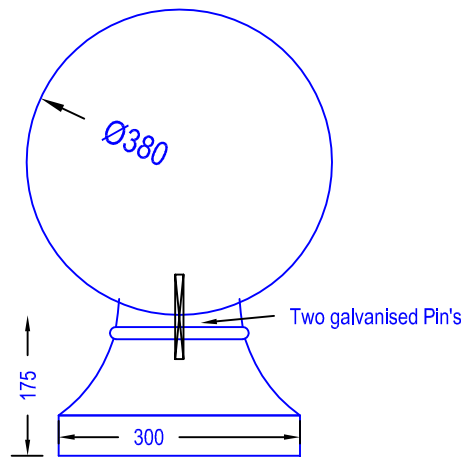

Finial Base  
SF3/380

\* Other designs can be made to suit customers requirements



**ILAM Stone Ltd**  
 Lydford Road  
 Meadow Lane  
 Industrial Estate  
 Alfreton  
 Derbyshire DE55 7RQ  
 Phone: 01773 520088 (general)  
 Phone 01773 520142 (sales & estimating)  
 Fax 01773 520077

# Weathered Capping

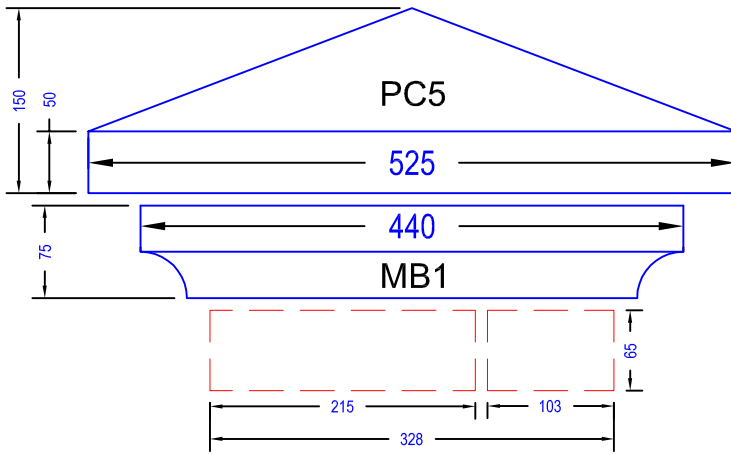

Capping PC5 with MB1

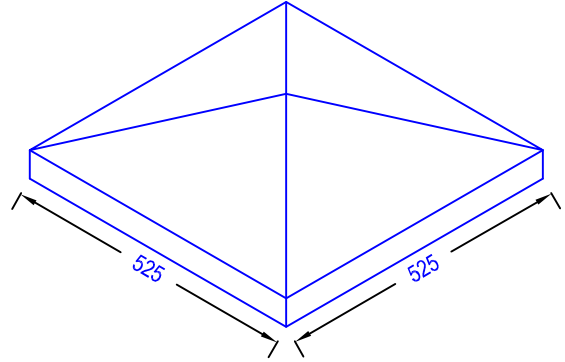

Capping PC5 525 x 525 x 150

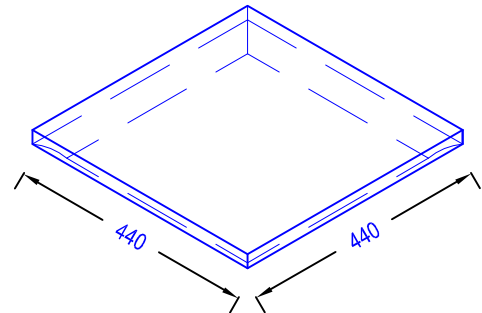

Sub Base to Capping MB1

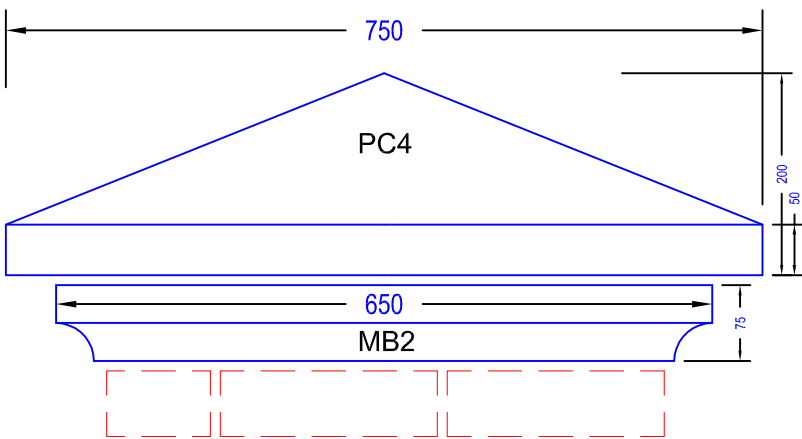

Capping PC4 with MB2

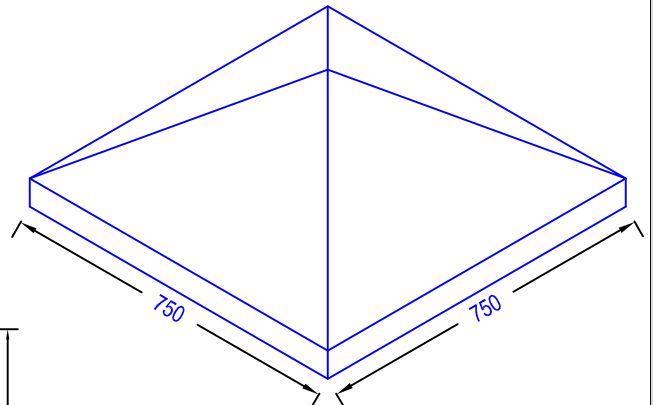

Capping PC4 750 x 750 x 200

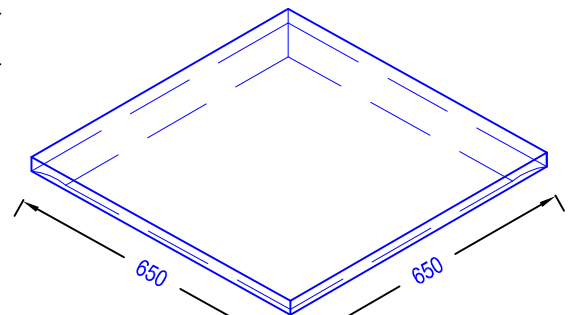

Sub Base to Capping MB2

\* Other designs can be made to suit customers requirements



ILAM Stone Ltd  
Lydford Road  
Meadow Lane  
Industrial Estate  
Alfreton  
Derbyshire DE55 7RQ  
Phone: 01773 520088 (general)  
Phone 01773 520142 (sales & estimating)  
Fax 01773 520077

# Pier Capping Set to fit 440 x 440 brick work

## PC6

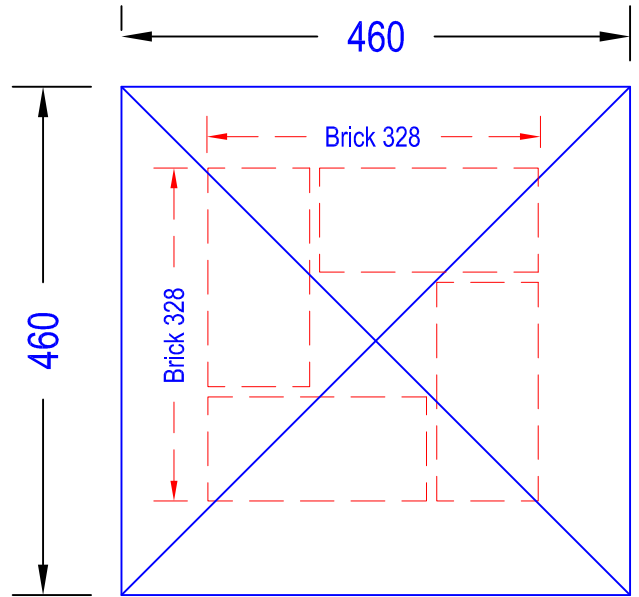
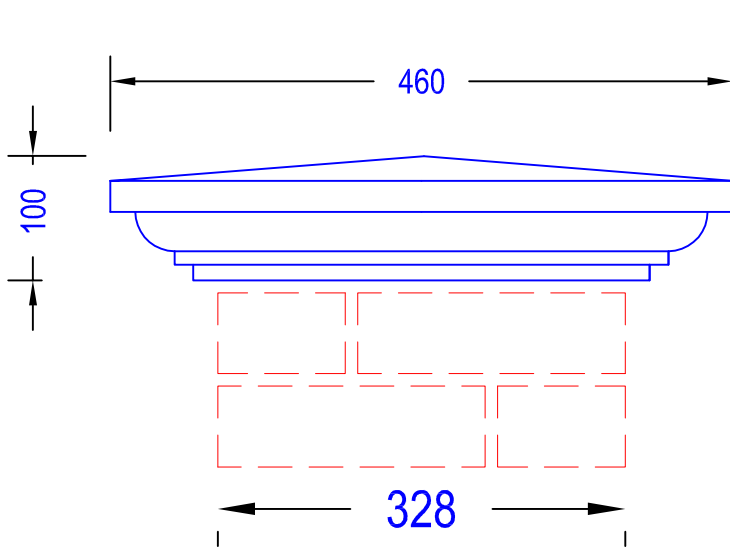

## PC7

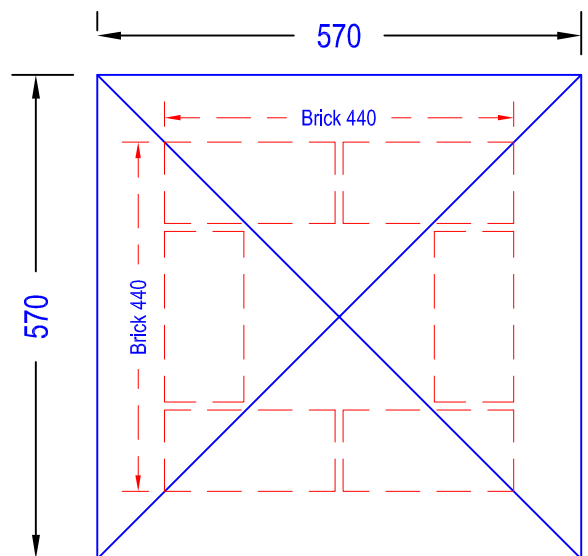
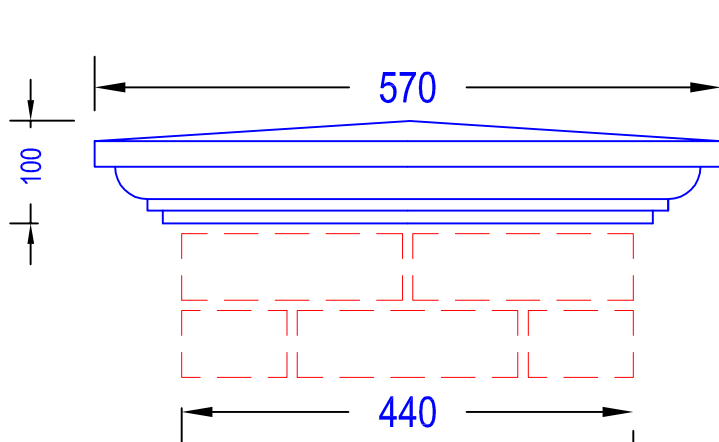

\* Other designs can be made to suit customers requirements



**ILAM Stone Ltd**  
 Lydford Road  
 Meadow Lane  
 Industrial Estate  
 Alfreton  
 Derbyshire DE55 7RQ  
 Phone: 01773 520088 (general)  
 Phone 01773 520142 (sales & estimating)  
 Fax 01773 520077

# Pier & Capping Set

to fit 330, 440, 552, 665 Brick Work

PC8

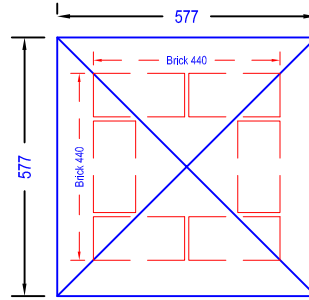
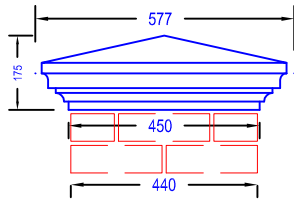

PC9

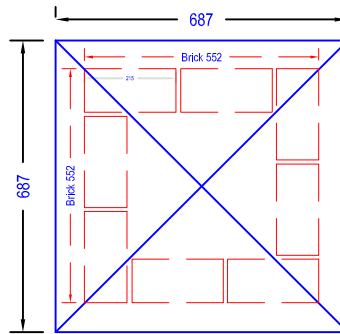
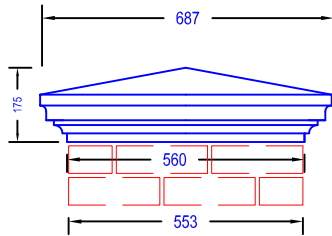

PC10

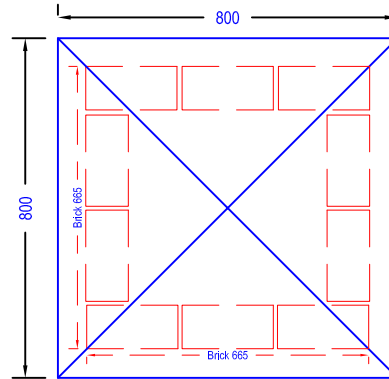
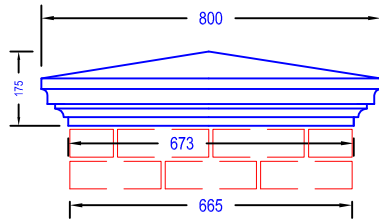

PC11

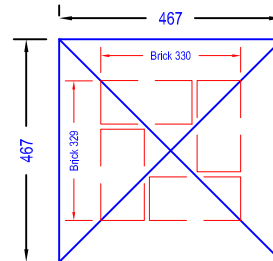
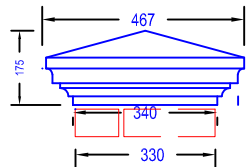

PC12

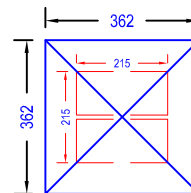
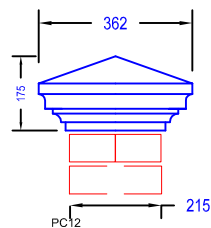

\* Other designs can be made to suit customers requirements



ILAM Stone Ltd  
Lydford Road  
Meadow Lane  
Industrial Estate  
Alfreton  
Derbyshire DE55 7RQ  
Phone: 01773 520088 (general)  
Phone 01773 520142 (sales & estimating)  
Fax 01773 520077

# Stone Pier & Capping

to fit 665 x 665 or 440 x 440

Note:- A 380mm Dim sphere is also available

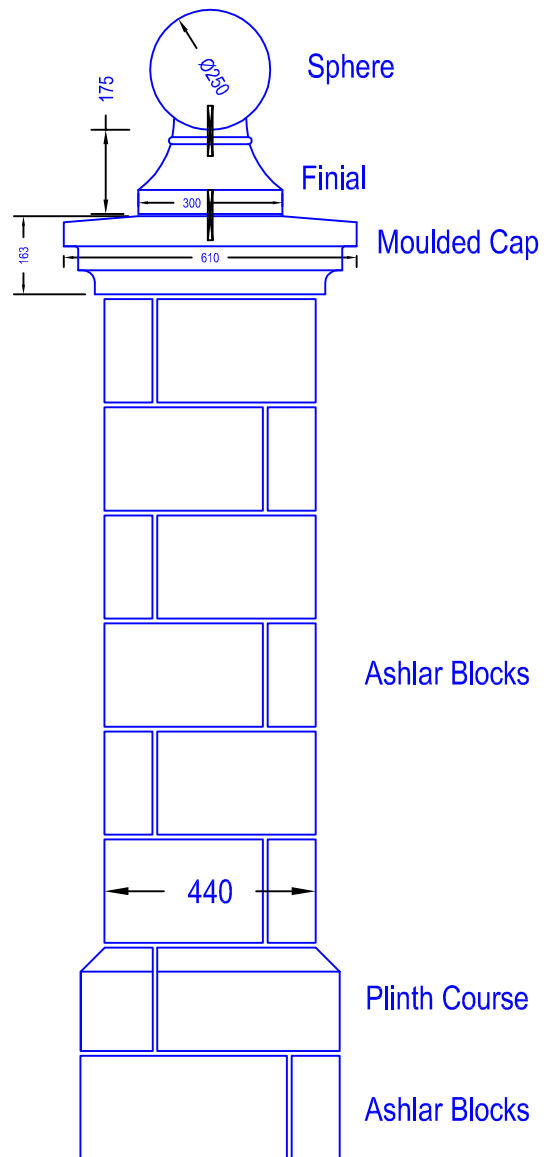
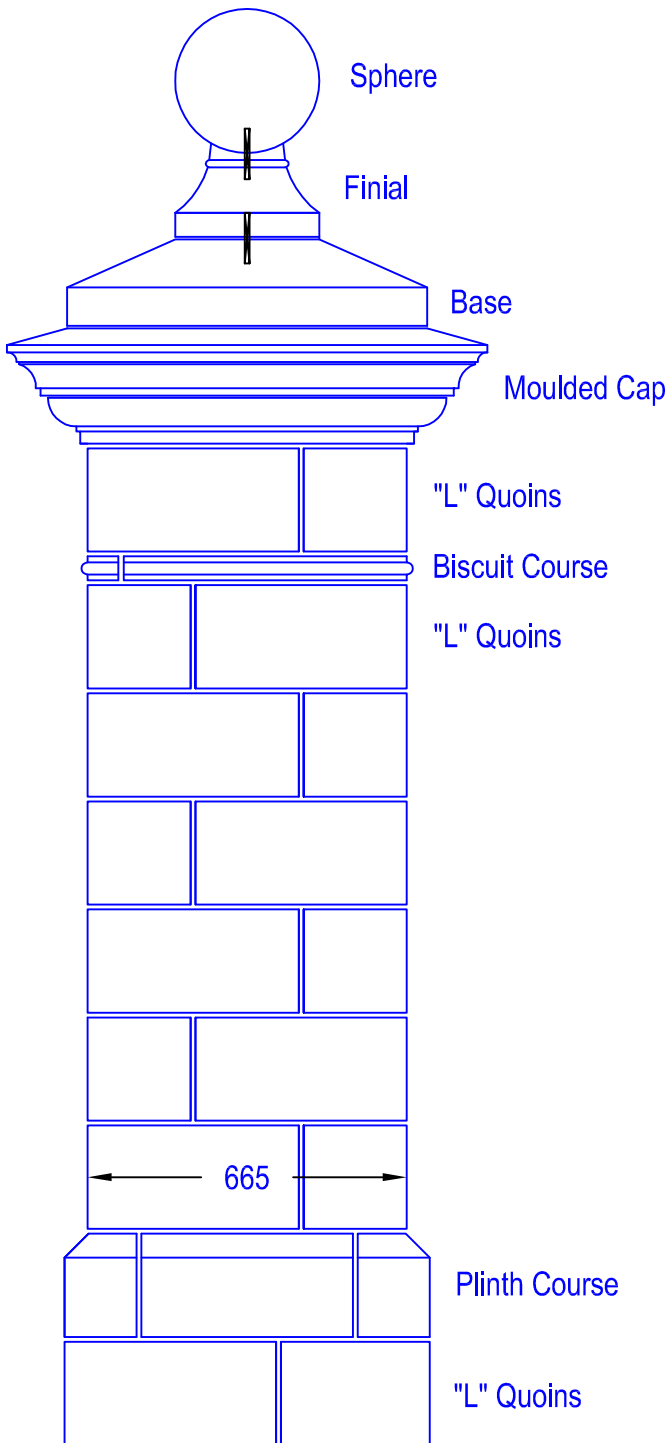

\* Other designs can be made to suit customers requirements





ILAM Stone Ltd  
Lydford Road  
Meadow Lane  
Industrial Estate  
Alfreton  
Derbyshire DE55 7RQ  
Phone: 01773 520088 (general)  
Phone 01773 520142 (sales & estimating)  
Fax 01773 520077

# Stone Pier & Capping

to fit 665 x 665 with sunken panel

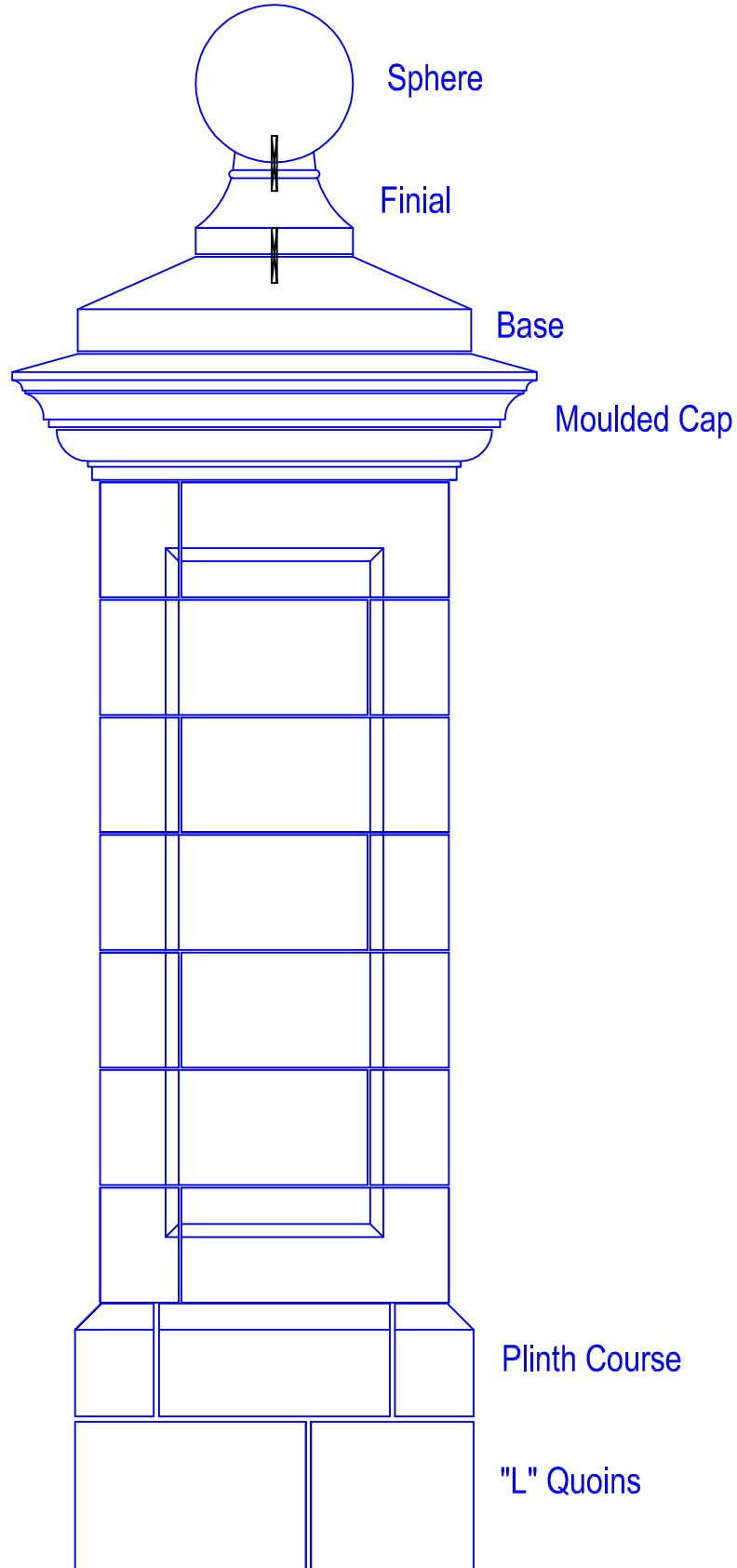

\* Other designs can be made to suit customers requirements